

# GuardCom System

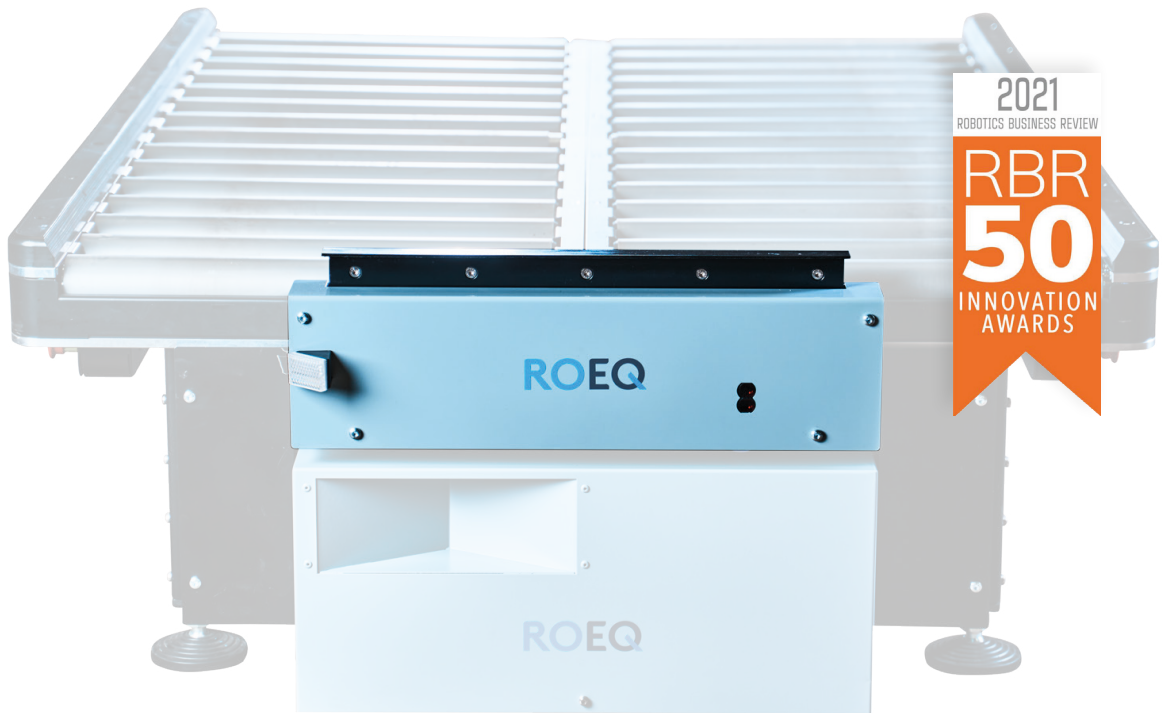

The ROEQ GuardCom System is an award-winning technology that enables quick, reliable, stable wireless data communication between ROEQ top modules and your stationary conveyor stations. Using proven and robust sensor technology, the ROEQ GuardCom doesn't depend on potentially unstable WiFi connections on your factory floor. This keeps your goods, conveyor lines and personnel safe from accidents.

In 2021, the ROEQ GuardCom solution made Robotics Business Review's RBR50 list. The list highlights the most creative and influential innovations from around the world that advance the state of robotics.

## Features

- Enables a "handshake" between the top roller and the static conveyor for a faster, safe transfer of cargo
- Ensures that the rollers on the top roller and static conveyor properly co-ordinate, also when safety area is disturbed
- Robust optical sensor technology not dependent on Wi-Fi for reliable safety
- Physical guard prevents goods from rolling off unintentionally
- Small footprint, so it takes up minimal space on the production floor
- Compatible with all ROEQ top rollers
- Compatible with all stationary conveyor stations
- Easy to install



## Specifications

**ROEQ product compatibility:**  
All ROEQ Top Rollers

**Size (l x w):**  
67mm x 586mm x 159mm - 189mm  
2.64" x 23.1" x 6.26" - 7.44"  
(height is including Guard up or down)

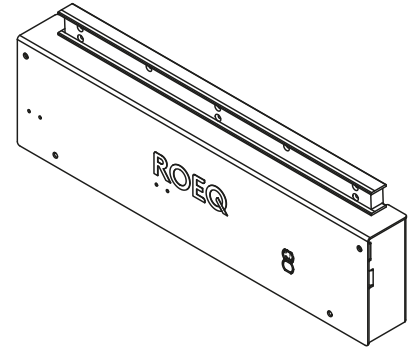
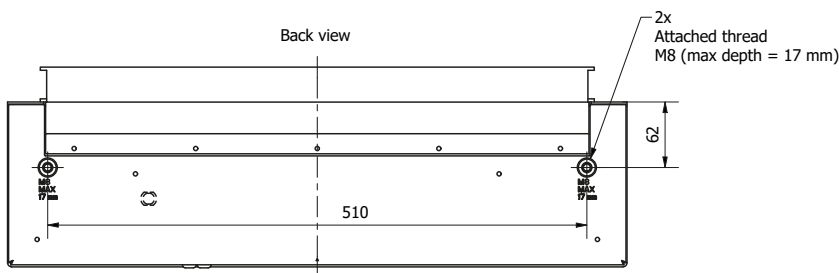
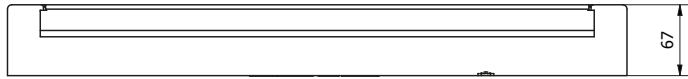
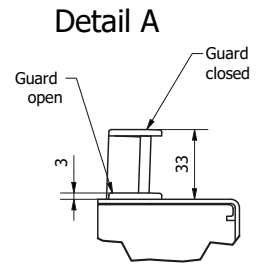
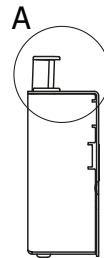
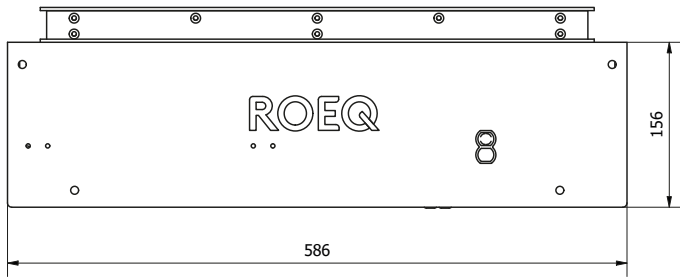



Product no.	Product name	Description	
273a1000	GuardCom	GuardCom unit to mount on stationary conveyor. Wireless communication, not using Wi-Fi	
273a2000	GuardCom Connect	Communications unit to mount on top rollers. Wireless communication with GuardCom, not using Wi-Fi	

Compatible with all ROEQ Top Roller Modules

Visit [roeq.dk](http://roeq.dk) for more information or to see films of products in action.

**Contact your local ROEQ Partner for more guidance**